

AUDICUS

The Wave

Hearing Aid
Instruction Manual

Rechargeable

WARNING: If you are younger than 18, do not use this.

You should go to a doctor, preferably an ear-nose-throat doctor (an ENT), because your condition needs specialized care. Over-the-counter hearing aids are only for users who are age 18 or older.

This OTC hearing aid is for users who are 18 and older. People who are younger than 18 with hearing loss should see a doctor, preferably an ENT because they may need medical testing and management. Hearing loss can affect speech and learning, so professional fitting and continuing care are also important.

WARNING: When to See a Doctor

If you have any of the problems listed below, please see a doctor, preferably an ear-nose-throat doctor (an ENT).

- Your ear has a birth defect or an unusual shape. Your ear was injured or deformed in an accident.
- You saw blood, pus, or fluid coming out of your ear in the past 6 months
- Your ear feels painful or uncomfortable
- You have a lot of ear wax, or you think something could be in your ear
- You get really dizzy or have a feeling of spinning or swaying (called vertigo)
- Your hearing changed suddenly in the past 6 months
- Your hearing changes: it gets worse then gets better again
- You have worse hearing in one ear
- You hear ringing or buzzing in only one ear

WARNING: This hearing aid should not cause pain when inserting it.

Remove the device from your ear if it causes pain or discomfort when you insert or place it. To try again, make sure to follow the instructions. If you feel pain or discomfort again, contact the manufacturer. If your pain or discomfort doesn't go away, contact your hearing healthcare professional. You can also report this to FDA as an adverse event according to the instructions that appear later.

Caution: This is not hearing protection.

You should remove this device if you experience overly loud sounds, whether short or long-lasting. If you're in a loud place, you should use the right kind of hearing protection instead of wearing this device. In general, if you would use ear plugs in a loud place, you should remove this device and use ear plugs.

Caution: The sound output should not be uncomfortable or painful.

You should turn down the volume or remove the device if the sound output is uncomfortably loud or painful. If you consistently need to turn the volume down, you may need to further adjust your device.

Caution: You might need medical help if a piece gets stuck in your ear.

If any part of your hearing aid, like the eartip, gets stuck in your ear, and you can't easily remove it with your fingers, get medical help as soon as you can. You should not try to use tweezers or cotton swabs because they can push the part farther into your ear, injuring your eardrum or ear canal, possibly seriously.

Note: If you remain concerned, consult a professional

If you try this device and continue to struggle with or remain concerned about your hearing, you should consult with a hearing healthcare professional.

Note: What you might expect when you start using a hearing aid

A hearing aid can benefit many people with hearing loss. However, you should know it will not restore normal hearing, and you may still have some difficulty hearing over noise. Further, a hearing aid will not prevent or improve a medical condition that causes hearing loss.

People who start using hearing aids sometimes need a few weeks to get used to them. Similarly, many people find that training or counseling can help them get more out of their devices.

If you have hearing loss in both ears, you might get more out of using hearing aids in both, especially in situations that make you tired from listening—for example, noisy environments.

Note: Tell FDA about injuries, malfunctions, or other adverse events.

To report a problem involving your hearing aid, you should submit information to FDA as soon as possible after the problem. FDA calls them "adverse events," and they might include: skin irritation in your ear, injury from the device (like cuts or scratches, or burns from an overheated battery), pieces of the device getting stuck in your ear, suddenly worsening hearing loss from using the device, etc. Instructions for reporting are available at <https://www.fda.gov/Safety/MedWatch>, or call 1-800-FDA-1088. You can also download a form to mail to FDA.

Welcome!

We're thrilled to be part of your hearing journey

This guide is an important resource.
Please set aside a few minutes to review
in order to get the most out of your
custom-tailored Audicus hearing aids

Audicus is with you every step of the way.
Find more info and help at
audicus.com/support

And remember, you're never on your own.
Reach out anytime, for anything at all.
(917) 999-0705 • help@audicus.com

What's inside?

Contents

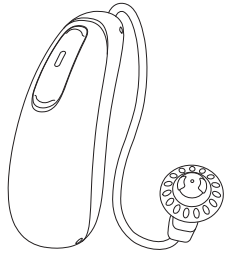

hearing aid(s) located
in the carrying case

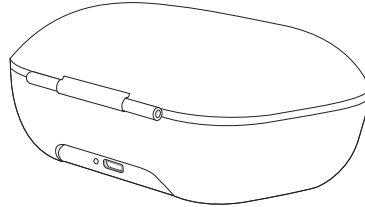

charging case

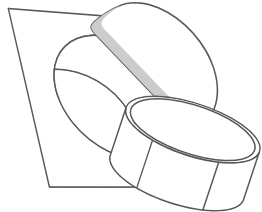

desiccant
drying capsule

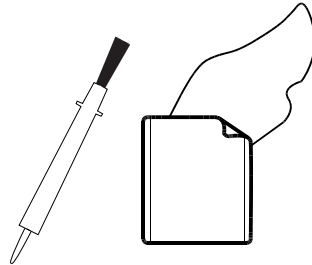

cleaning brush & audiowipes



dome variety pack
– small, medium large
(styles dependent on
hearing loss)

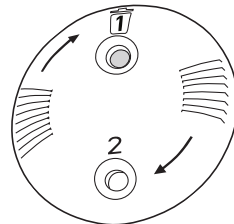

earwax guard
dispenser tool

Getting Started..... page 8

Troubleshooting..... page 16

Using The Wave..... page 18

Bluetooth..... page 26

Device Information..... page 32

Your hearing aid at a glance

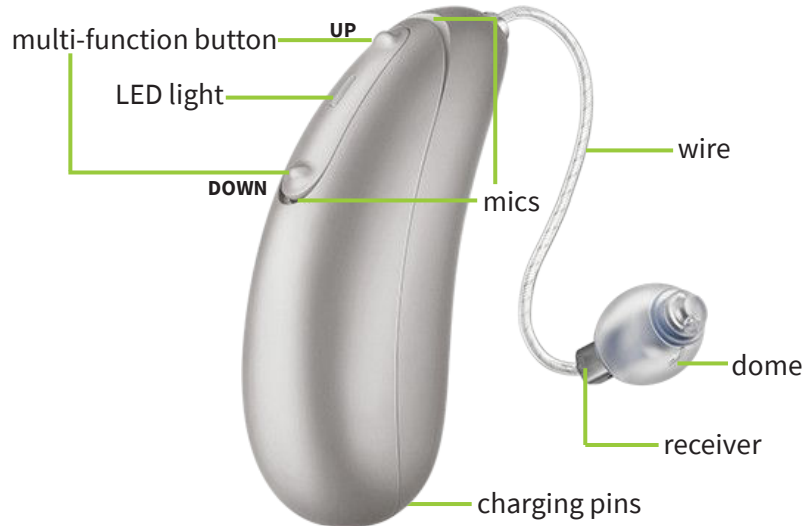

multi-function button – changes volume, switches programs, answers/ends calls

dual microphones – where sound enters your hearing aid

LED light – indicator of power status and charge level

receiver wire – connects receiver (speaker) to hearing aid

receiver – amplifies sounds into the ear canal and contains the **earwax guard** in the tip

dome – grey hypoallergenic silicone cover on the receiver to hold in place comfortably

charging pins – short metal prongs to facilitate charging

Turning on / off

Your hearing aid will **turn OFF while charging**

Depending on your settings, the hearing aid may **remain OFF** or **turn ON** when removed from the charging case / disconnected from power. A green flash on removal indicates the device is **ON**

To turn the device **ON** or **OFF**:
Press and hold the **DOWN button** for 5 seconds

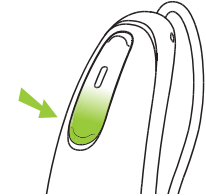

turning ON

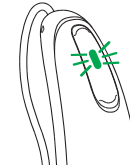

Green light and melody 🎵

turning OFF

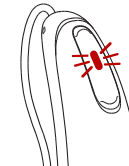

Long red light and two long tones

Low battery warning



2 beeps

~30 mins remaining

Charging your hearing aid

Your hearing aid contains an **lithium-ion battery** that is recharged with the **charging case** via **micro-USB**

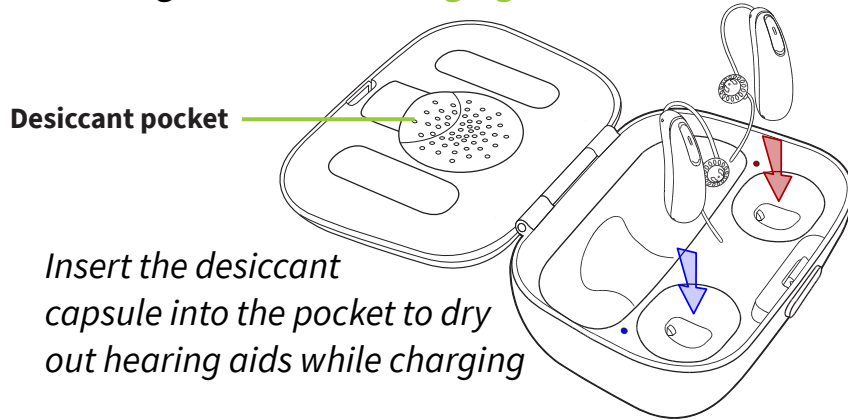

1. Gently insert your device into the charging case. Match the colored marker on the device to the indicator on the charging case

2. Power the charging case via the included USB cable. The charging case will show a **steady green light** when powered and the LED light on the hearing aid will blink while the device charges

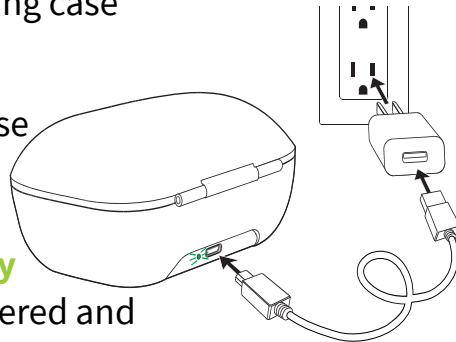

3. When the hearing aid light is **solid green**, the hearing aid is fully charged and ready for use

Hearing Aid LED light indicator of charge

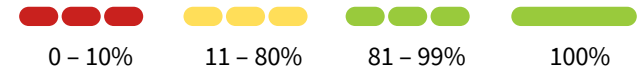

4. Hold the device by the plastic shell to remove
Do not pull the hearing aid by the wire as this may damage the device

Do not leave the hearing aids in the charger for longer than 48 hours. If you will not be using your devices remove them from the charger and turn off



- To keep your aids charged on the go, consider the **Power Pack**: an external battery for wire-free charging
- The Power Pack holds 7 days of charge and simply connects into the bottom of the charging case audicus.com/power-pack

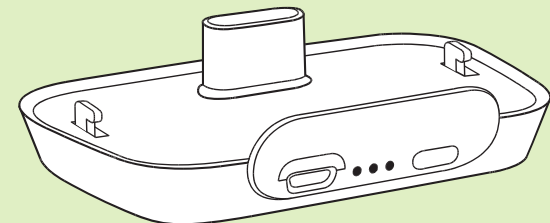

Putting on your hearing aid

Hearing aids are color-coded with a marking on the back of the device: **blue = left** **red = right**

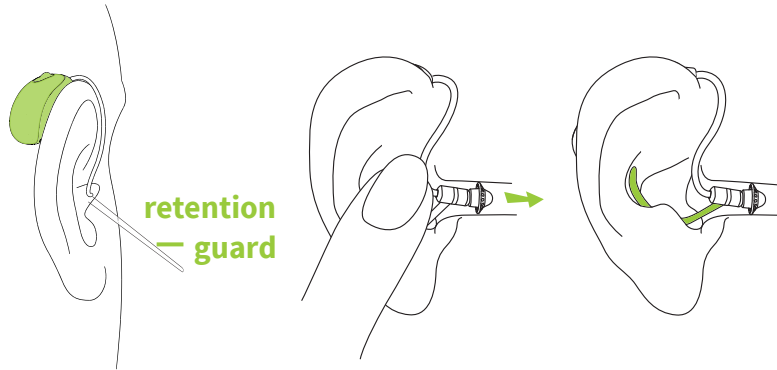

1. Clean your **ear** and **hearing aid** before every use
2. We recommend using a mirror to practice. First, place the hearing aid body over the top of your ear
3. Hold the wire near the dome and gently push the dome into your ear canal. Pull up and back on the cartilage of the ear to ease insertion
4. Trim retention guard to a comfortable length with scissors or remove altogether. Place the retention guard so it rests in the bowl of your ear

Handle your hearing aid with care. Do not pull on or bend the wire as this may cause damage

Adding/Removing the Retention Guard

We recommend using the retention for a more stable positioning of the receiver in the ear canal

To add

1. Hold the receiver firmly in one hand with the receiver text (e.g., 2M) facing upwards. In the other hand hold the retention guard at the base of the filament
2. Slide the retention over the receiver spout until you feel it click into place. The receiver text should still be clearly visible

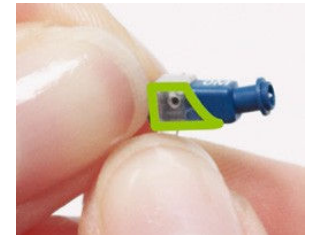

To remove

1. Hold receiver firmly with one hand
2. Slide the retention guard forward over the receiver spout. The retention guard can be trimmed with scissors to a comfortable length

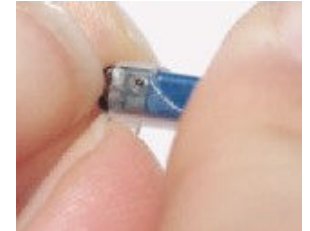

Volume & program

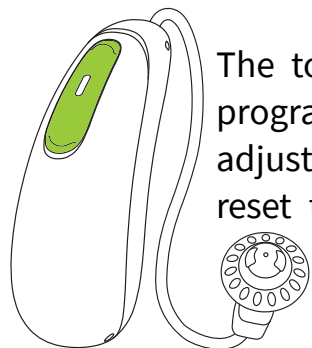

The toggle button controls volume and program settings. Both hearing aids are adjusted simultaneously. Turning off will reset the device to the **default volume** and **program 1**

Increase volume: short press the **UP** button

Decrease volume: short press **DOWN** button



From the default volume you can adjust 5 steps up or down. When you hear a double tone, that means you've reached the max / min volume

Long press (>2sec) to change the the **program**. The number of 🎵beeps indicates the program choice

Standard Programs:

1 🎵 Auto-adapt / universal

2 🎵 Conversation in noise

3 🎵 Auditorium

4 🎵 Car/Plane

Adjusting to your new hearing aid

Your hearing aid is programmed to you individually

Adjusting to hearing aids fully may take up to 6 weeks

1. You may hear sounds you haven't heard in years
 - Sounds will be amplified and more distinguished, e.g., leaves rustling, running water, your own voice
 - **Sensitivity to 'new' sounds is normal** and will go away with regular use
2. Find the right dome for your ear
 - Your hearing aid ships with a **size medium dome** attached, with an additional variety pack of domes
 - Use the "**Finding the right dome**" guide if you have any discomfort or hear a whistling sound
3. It may take a few weeks to get used to the fit and feel of your hearing aid. Contact Audicus for guidance and tips on fit and comfort
4. Your aid is programmed to your specific hearing test; it may take some time to become accustomed. After a few weeks of daily use – if you'd like an adjustment – just contact us

Troubleshooting

Cause

Remedy

No sound or weak sound

Not turned on	See page “Turning on / off”
Low / dead battery	Place device in charging case
Dome blocked with debris / earwax	Clean dome and replace earwax guard. See page “Replacing the dome and earwax guard”
Clogged microphone	Clean device with cleaning brush. If issue persists, contact Audicus

Feedback / whistling

Object or clothing near device	Move any objects or clothing away from device
Dome not inserted properly	See “Putting on your hearing aid”
Poorly fitted dome	See “Finding the right dome”

Bluetooth

Bluetooth not connecting	See “Bluetooth Troubleshooting” Not all phones work well with Bluetooth devices
--------------------------	--

Cause

Remedy

Hearing Aid won't turn on

Device needs to be reset	<ul style="list-style-type: none">• Hold DOWN button for 20 seconds• Put the device in the charging base for 30 seconds• Remove and device is now reset
--------------------------	---

Two long beeps

Low battery	Charge device in charging case
-------------	--------------------------------

LED light off while in charging case

Charger not connected to power source	Ensure the USB cable is plugged into the back of the charging case and into a powered outlet
Hearing aid not inserted correctly	See “Charging your hearing aid”
Dirty charging pins	Clean aid and charger with a dry cloth

LED light fast blinking while charging

Temperature issue or faulty battery	Ensure device is between 50-100°F (10-40°C). Contact if issue persists
-------------------------------------	--

Finding the right dome

The dome is the small, grey silicone tip on the end of the hearing aid that is inserted into your ear

Domes come in a variety of shapes and sizes. The proper choice of dome style and size can help with comfort and sound quality

New hearing aids come pre-fit with a medium size dome in your recommended dome style

Dome styles and sizes

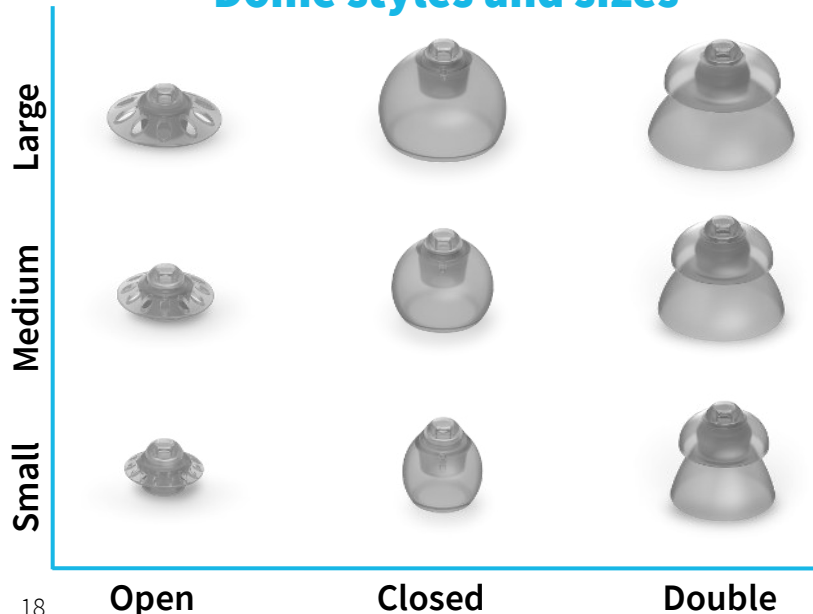

New orders include a variety of dome sizes and styles. Depending on your specific hearing loss, your order may not include all dome styles

Take some time to find which size dome is right for you. The dome should fit snugly in your ear canal and inserted far enough to not be visible

If missized or the wrong style, you may hear feedback: a squealing or whistling sound that can be resolved with a different dome size or style

Order new domes at audicus.com/wave-supplies



- Clean your domes regularly
- Replace old, brittle, discolored or damaged domes or if they pull off the hearing aid easily
- Earwax production is different for each person. Replace domes as needed, at least every 2–3 months
- Always ensure that a new dome is firmly attached to the receiver before inserting into your ear

Caring for your hearing aid

With regular maintenance your devices will sound great for years to come

Daily: Clean with with a lint-free cloth or non-alcoholic Audiowipe. Allow earwax to dry and harden before brushing off. Charge in charging case overnight

Weekly: Remove earwax and debris from device and dome using supplied cleaning brush

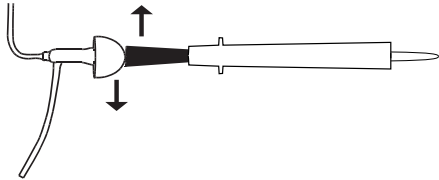

Quarterly: Domes, earwax guards and desiccant drying capsules should be replaced at least every 2–3 months



- Everybody's ears are different: you may need to clean your devices more frequently
- Never use cleaning agents such as detergent, soap, alcohol or bleach to clean your hearing aid
- Do not submerge your hearing aid or rinse your hearing aid under water

Audicus Care

All the products to care and maintain your device are available at audicus.com/wave-supplies

Audicus Care is the easiest way to get everything you need to maintain your Wave. Sign up and you'll receive an unlimited supply of domes, earwax guards, wipes, desiccant drying capsules and cleaning brushes conveniently delivered every 3 months or when requested. Never worry about running out of hearing aid supplies again. Find out more at audicus.com/care

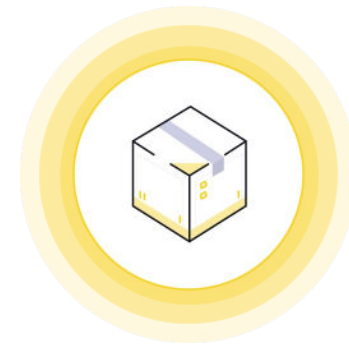

Sign up at:
audicus.com/care

Replacing the dome and earwax guard

- A.** To remove the dome: hold the receiver with one hand and gently pull off the dome with the other hand

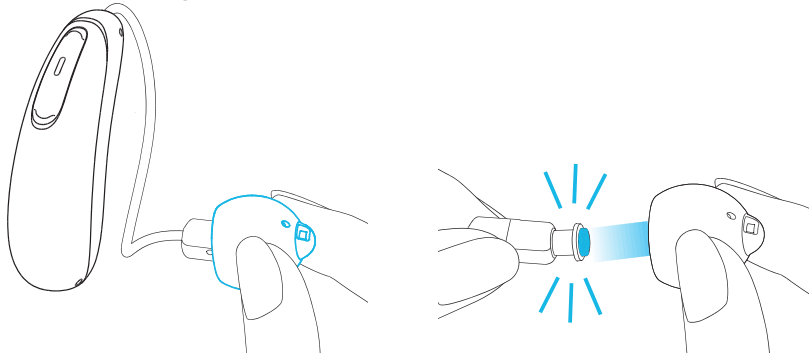

- B.** You now have access to change the **earwax guard**

The earwax guard is a very small, white plastic filter inserted into the receiver tip. The earwax guard collects and prevents earwax from entering the receiver, which may impair or damage the device

Replace the earwax guard **at least every 2-3 months** or **any time the sound quality is diminished**

Your order comes with a grey circular accessory which contains eight new earwax guards and is also the earwax guard removal tool

Used earwax guards are disposed here

New earwax guards are stored here

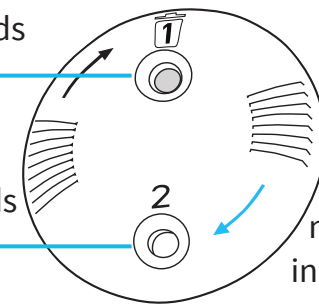

Rotate to expose new earwax guard in **chamber 2**

- C.** To dispose of the used earwax guard: first ensure **chamber 1** is empty. Then press the receiver in until it “clicks” – this will remove the used earwax guard

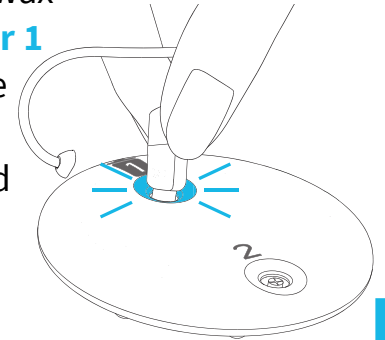

- D.** Ensure the receiver is empty and a new earwax guard is visible in **chamber 2**. Press the empty receiver into **chamber 2** and the earwax guard should be inserted into the receiver

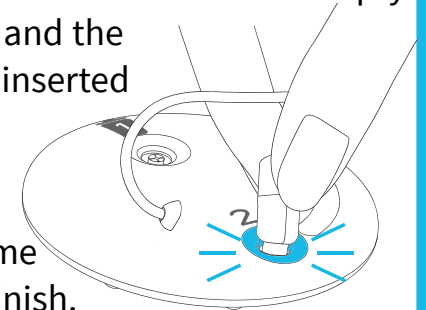

- E.** Reattach the silicone dome onto the receiver to finish.

Order replacement earwax guards at [audicus.com/wave-supplies](https://www.audicus.com/wave-supplies)

Protecting your aid

- Store your device in the charging case when not in use. If storing for an extended period simply turn off and store in a clean and dry environment. Do not store in an unplugged charging case
- Never wear your hearing aid in the shower, bath, sauna or while swimming. Keep protected from rain
- If the hearing aid becomes wet, ensure the aid is dry before using. Do not dry in an oven or microwave
- Replace the desiccant drying capsule in the charging case every 2–3 months

Lift to access

desiccant pocket

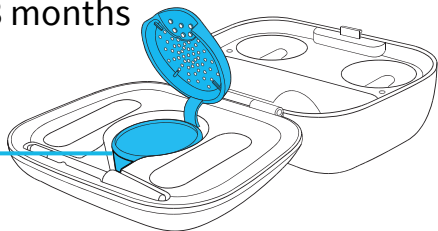

- Keep your hearing aid away from sources of high temperature. Do not leave your hearing aid in direct sunlight or wear while using a hair dryer
- Keep hearing aids away from children and pets

Clean & Care, Repairs and Audicus Protect

Your hearing aids come with a **24 month** manufacturer's warranty. Additional repairs may incur costs depending on the severity

Accidents happen. **The Audicus Protect plan** has you covered. With Audicus Protect you have complete coverage of your hearing aids for **36 months**, including low-cost repairs, free Clean & Care service and reduced-price loss replacement. Audicus Protect must be purchased within 60 days of delivery



Sign up at:

audicus.com/protect

Audicus offers a **Clean & Care service** to have your instruments professionally checked and cleaned, find out more at **audicus.com/clean**

If you return your aids to Audicus dirty, you may be billed for the Clean & Care service

Bluetooth - Pairing your hearing aid

Your hearing aid has built-in **Bluetooth® connectivity**, allowing you to connect with devices that support Bluetooth 4.2 or higher, including most modern Apple iOS or Android smartphones

When connected to a smartphone your hearing aid is able to play music and answer calls hands-free

In your phone's settings menu:

- Turn on Bluetooth
- Search for new devices

Hearing aid pairing starts automatically on start-up

- The device enters Bluetooth pairing mode for 3 minutes after being turned on
- From the list of available devices, select your hearing aid to simultaneously pair both devices
- **Only connect to the Right ("R-") hearing aid**
- A melody is played when successfully paired 🎵



Once paired, your hearing aids will automatically reconnect when in range of your phone. **This reconnection can take up to 2 minutes**

Hands free calls

- When paired, phone calls are automatically transferred to your hearing aids. Your voice is picked up by the hearing aid's microphones
- To accept an incoming call, you will first hear a notification through the hearing aids
- The call can be **accepted** by a **short press** on the multi-function button (either **UP** or **DOWN**) or rejected with a **long press** (over 2 seconds)
- Alternatively, accepting the phone call on your phone will transfer the call to your hearing aids
- **End a call** with a **long press** on your multi-function button (either **UP** or **DOWN**)



- Pairing is only necessary once per phone
- Bluetooth connection will extend to 30ft / 10m but can be reduced by obstructions in a purse or pocket
- Bluetooth connection will cause extra battery drain. If hearing aids are not connected via Bluetooth there will be no extra battery loss
- See audicus.com/support for help with Bluetooth

Flight mode

The wireless and Bluetooth functions of your hearing aid can be temporarily disabled in **flight mode**. This will not disable normal hearing aid functionality

To enter flight mode:

1. Turn **OFF** the device by pressing and holding the **DOWN** button (see page “**Turning off / on**”)
2. Press and hold the **DOWN** button on the hearing aid for 7 seconds until an **orange LED** light is seen. The devices are now in flight mode

To exit flight mode:

1. Turn **OFF** or **charge** the hearing aid. Wireless functionality will resume when turned back on

Bluetooth Troubleshooting

Not all phones work well with Bluetooth devices

Follow these steps if you are having trouble connecting or experiencing poor audio with Bluetooth:

1. **Disconnect** aids from remote app, if installed
Settings › My Hearing Aids › My Devices › Forget Devices
2. **Uninstall** the Hearing Remote app, if installed
3. **Delete/forget** hearing aids from Bluetooth menu
4. Check for and **install any updates** on your phone
5. **Disable/enable** or turn off/on Bluetooth
6. **Restart** your phone
7. **Restart** the hearing aids (hold the DOWN button)
8. **Reconnect** one hearing aid via Bluetooth menu

If desired, install the Hearing Remote app and connect devices in the app. The Hearing Remote **app is not required** for basic Bluetooth usage and is not supported on all phones

For additional support visit audicus.com/support

Optional Hearing Remote App

Your device works **without an app** with any compatible Bluetooth devices

For additional functionality, control, and remote adjustment, you can use the optional smartphone app. Note: this app may not be compatible with all smartphones

The free **Hearing Remote** app can be downloaded from the App Store (iOS) or Play Store (Android). Find links at audicus.com/app



Requirements for the **Hearing Remote app**:

iOS

version 10.2+



Android

version 6.0+



TV Connector

The TV Connector allows you to **wirelessly connect** your hearing aids to your TV/stereo/laptop, etc. The TV Connector sends wireless audio signals up to 15m (50ft). Accepts audio signals via either a 3.5mm audio cable or a digital optical TOSLINK and is powered via USB



Order your Wave accessories at audicus.com/wave-supplies

Returns and warranty

The Audicus 100% happiness guarantee

If for any reason you are not satisfied with your Audicus hearing aids, you may return it within 45 days after delivery date for a full refund of the original purchase price

This guarantee is only possible if the hearing aid has not been modified, tampered with, damaged or repaired by the user. Please see return instructions at audicus.com/returns

Manufacturer warranty

All Audicus hearing aids come with a 24 month guarantee that covers manufacturing defects. This guarantee will not be valid if the hearing aid has been modified, tampered with, damaged or repaired by the user. Hearing aids must be cleaned prior to any repairs, otherwise a cleaning fee will apply

If your device stops functioning correctly reach out to contact@audicus.com or (917) 999-0705

FDA information

Use your hearing aid all day long

The best way to ensure better hearing is to practice listening with your hearing aid until you are able to wear it comfortably all day. Generally, infrequent use of the hearing aid does not provide you with the full benefit of amplification.

Your hearing aid will not restore normal hearing. Hearing aids will not prevent or improve hearing impairment resulting from a physiological condition. Hearing aids will help you to make better use of your residual hearing.

The use of hearing aids is only part of hearing rehabilitation; auditory training and lip reading instruction may be required as well.

Possible side effects

If you are experiencing discomfort, contact Audicus or your hearing care professional for modification of the hearing aid at the point of irritation. A hearing aid may cause an accelerated accumulation of cerumen (earwax). Also in rare cases, the otherwise nonallergenic material may cause a discharge from the ear, allergic reaction, or any other unusual condition. Please seek immediate consultation with a physician if these conditions occur.

Technical information

The Audicus Wave is manufactured by Unitron Hearing, Canada and distributed by Audicus.

FCC ID: KWC-LDR IC: 2262A-LDR

Hereby, Unitron Hearing declares that this product meets the requirements of the Medical Device Directive 93/42/EEC and complies with Radio Equipment Directive 2014/53/EU.

Changes or modifications not expressly approved by Audicus may void the FCC authorization to operate this device.

This device complies with Part 15 of the FCC Rules and with RSS-210 of Industry Canada. Operation is subject to the following two conditions:

- (1) This device may not cause harmful interference and
- (2) this device must accept any interference received, including interference that may cause undesired operation.

This equipment has been tested and found to comply with the limits for a Class B digital device, pursuant to Part 15 of the FCC Rules and ICES-003 of Industry Canada. These limits are designed to provide reasonable protection against harmful interference in a residential installation. This device generates, uses and can radiate radio frequency energy and, if not installed and used in accordance with the instructions, may cause harmful interference to radio communications.

However, there is no guarantee that interference will not occur in a particular installation. If this equipment does cause harmful interference to radio or television reception, which can be determined by turning the equipment off and on, the user is encouraged to try to correct the interference by one or more of the following measures:

- Reorient or relocate the receiving antenna.
- Increase the separation between the equipment and receiver.
- Connect the device into an outlet on a circuit different from that to which the receiver is connected.
- Consult the dealer or an experienced radio/TV technician for help.

Operating conditions:

This device is designed such that it functions without problems or restrictions if used as intended, unless otherwise noted in these user guides.

Transport conditions:

Temperature Limits: -20°C (-4°F) to $+60^{\circ}\text{C}$ ($+140^{\circ}\text{F}$)

Humidity: Lower Limit = 0%, Upper Limit = 70%

Pressure: Lower Limit = 50kPA, Upper Limit = 106kPA

Radio information of your wireless hearing aid:

Antenna type: Resonant loop antenna

Operation frequency: 2.4 – 2.48 GHz

Radiated Power: $<2.5\text{mW}$

Bluetooth: 4.2 Dual-Mode

Profiles supported: HFP (Hands-free profile), A2DP



The Bluetooth® word mark and logos are registered trademarks owned by Bluetooth SIG, Inc. and any use of such marks by the manufacturer is under license. Other trademarks and trade names are those of their respective owners.



Keep dry



The symbol with the crossed-out garbage bin is to make you aware that this device may not be thrown away as normal household waste. Please dispose of old or unused devices at waste disposal sites intended for electronic waste, or give your device to your hearing care professional for disposal. Proper disposal protects the environment and health.

Warning to hearing aid dispensers (to comply with the U.S. Food and Drug Administration (FDA) regulations)

Hearing aid dispenser should advise a prospective hearing aid user to consult promptly with a licensed physician (preferably an ear specialist) before dispensing a hearing aid if the hearing aid dispenser determines through inquiry, actual observation, or review or any other available information concerning the prospective user, that the prospective user has any of the following conditions:

- i. Visible congenital or traumatic deformity of the ear.
- ii. History of active drainage from the ear within the previous 90 days.
- iii. History of sudden or rapidly progressive hearing loss within the previous 90 days.
- iv. Acute or chronic dizziness.
- v. Unilateral hearing loss of sudden or recent onset within the previous 90 days.
- vi. Audiometric air-bone gap equal to or greater than 15 decibels at 500 hertz (Hz), 1000 Hz and 2000 Hz.
- vii. Visible evidence of significant cerumen accumulation or a foreign body in the ear canal.
- viii. Pain or discomfort in the ear.

Important notice for prospective hearing aid users

Good health practice requires that a person with a hearing loss have a medical evaluation by a licensed physician (preferably a physician who specializes in diseases of the ear) before purchasing a hearing aid. Licensed physicians who specialize in diseases of the ear are often referred to as otolaryngologists, otologists, or otorhinolaryngologists. The purpose of medical evaluation is to assure that all medically treatable conditions that may affect hearing are identified and treated before the hearing aid is purchased.

Following the medical evaluation, the physician will give you a written statement that states that your hearing loss has been medically evaluated and that you may be considered a candidate for a hearing aid. The physician will refer you to an audiologist or a hearing aid dispenser, as appropriate, for a hearing aid evaluation.

The audiologist or hearing aid dispenser will conduct a hearing aid evaluation to assess your ability to hear with and without a hearing aid. The hearing aid evaluation will enable the audiologist or dispenser to select and fit a hearing aid to your individual needs.

If you have reservations about your ability to adapt to amplification, you should inquire about the availability of a trial-rental or purchase-option program. Many hearing aid dispensers now offer programs that permit you to wear a hearing aid for a period of time for a nominal fee after which you may decide if you want to purchase the hearing aid.

Federal law restricts the sale of hearing aids to those individuals who have obtained a medical evaluation from a licensed physician. Federal law permits a fully informed adult to sign a waiver statement declining the medical evaluation for religious or personal beliefs that preclude consultation with a physician. The exercise of such a waiver is not in your best health interest and its use is strongly discouraged.

Children with hearing loss

In addition to seeing a physician for a medical evaluation, a child with hearing loss should be directed to an audiologist for evaluation and rehabilitation since hearing loss may cause problems in language development and the educational and social growth of a child. An audiologist is qualified by training and experience to assist in the evaluation and rehabilitation of a child with a hearing loss.

Technical specifications

	<u>Standard Receiver</u>	<u>Medium Receiver</u>
Output Sound Pressure Level 90 (OSPL90) (dB SPL)	111	114
Full on gain (input 50 dB SPL)	46	50
Total harmonic distortion at 500Hz/800Hz/1600Hz/3200Hz (%)	1.5/2.0/2.0/1.0	
Equivalent input noise at Reference Test Setting (dB SPL)	19	
Latency (ms)	<8	
Frequency range (Hz)	<100-8000	
Typical battery life (h)	18	



audicus.com •
(917) 999-0705 •
help@audicus.com •